

Verrière - Internal glass window - Glastrennwand - Binnenraam

ORANGERIE

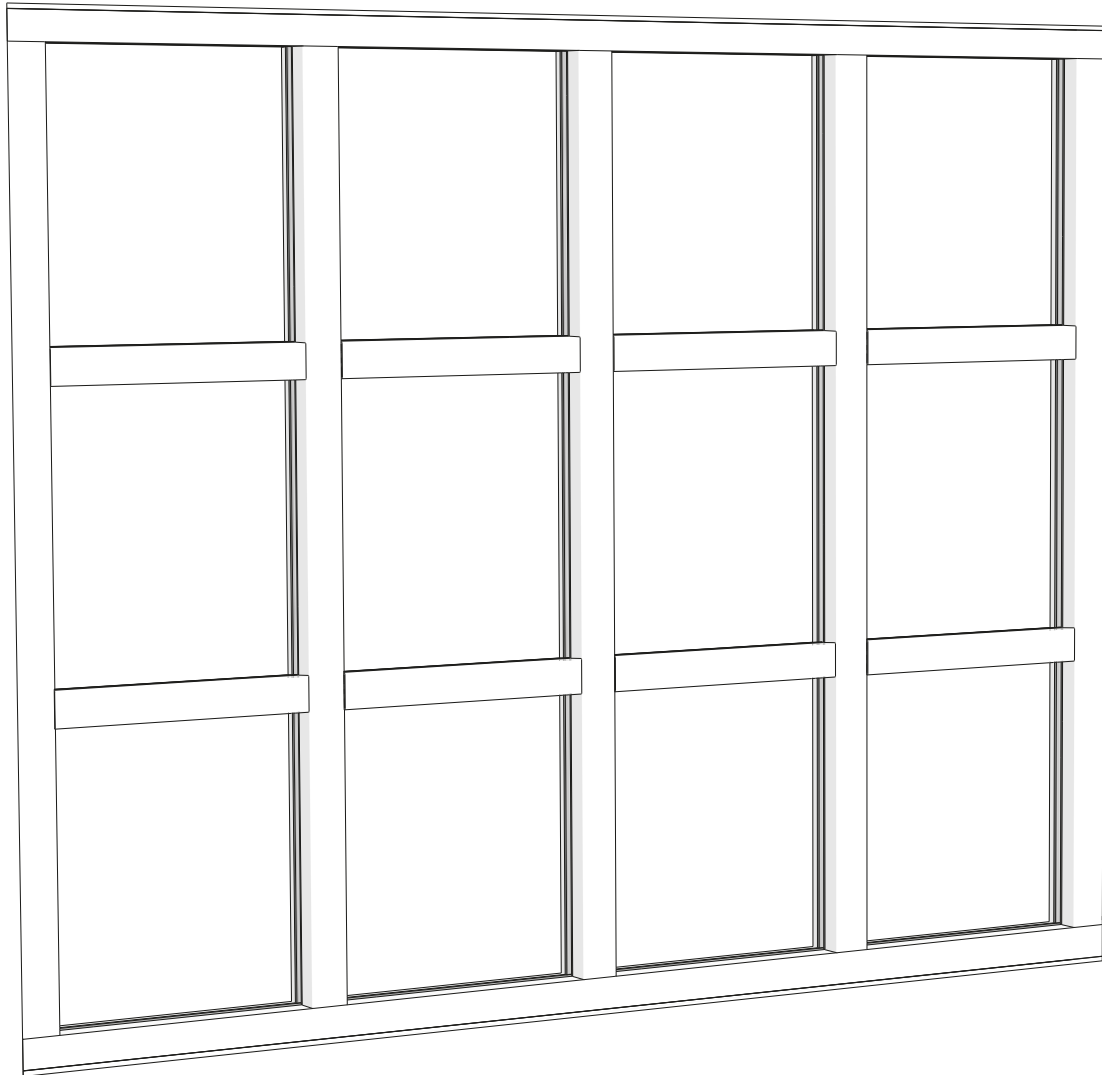

Ces instructions de montage s'appliquent à tous les modèles de verrière.

These assembly instructions apply to all glass windows.

Montageanleitung gilt für alle Glastrennwand-Ausführungen.







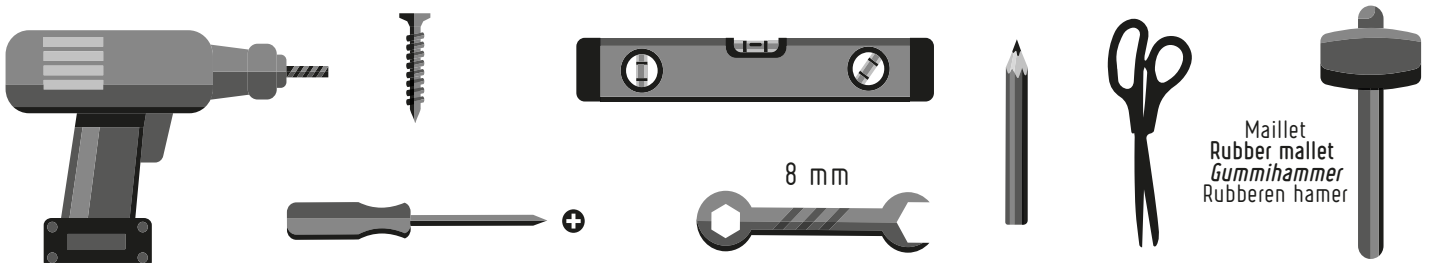





Deze plaatsingsinstructies gelden voor alle modellen binnenramen.

MATÉRIEL NÉCESSAIRE / NEEDED TOOLS / BENÖTIGTE WERKZEUGE / BENODIGD GEREEDSCHAP

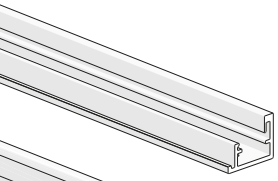

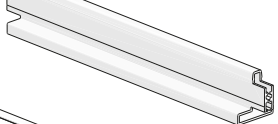
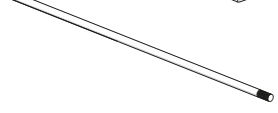
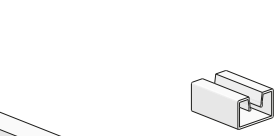
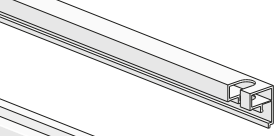
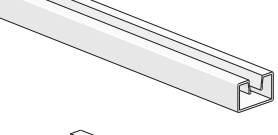
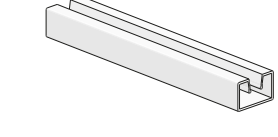
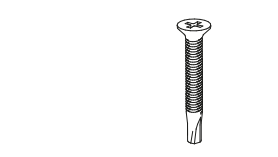

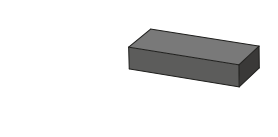
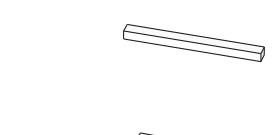
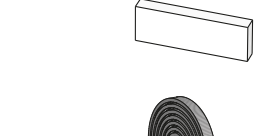







(non fourni / not provided / nicht im Lieferumfang enthalten / niet meegeleverd)

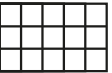

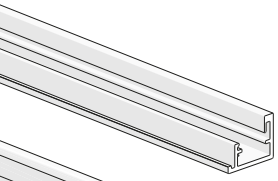

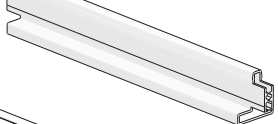
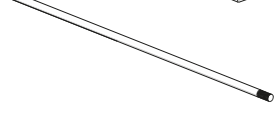
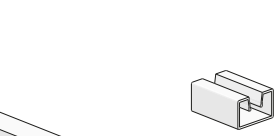
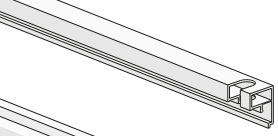
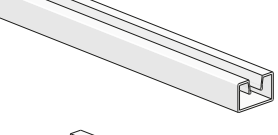
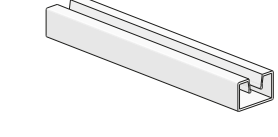
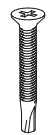

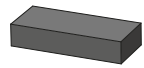
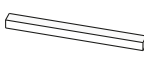
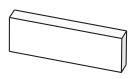

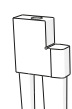

COMPOSITION DE VOTRE COLIS / INCLUDED IN THE PACKAGE / PACKETINHALT / INHOUD VAN DE VERPAKKING

Hauteur 2 carreaux		x1	x2	x3	x4	x5	x6	x7
								
	A Profil Profile Profil Profiel	x2	x2	x2	x2	x2	x2	x2
	B Profil Profile Profil Profiel	x2	x3	x4	x5	x6	x7	x8
	C Profil Profile Profil Profiel	x1	x2	x3	x4	x5	x6	x7
	D Tige Spindle Stange Draadstang	x1	x1	x1	x1	x1	x1	x1
	E Profil Profile Profil Profiel	x1	x2	x3	x4	x5	x6	x7
	F Profil Profile Profil Profiel	x2	x2	x2	x2	x2	x2	x2
	G Profil Profile Profil Profiel	x2	x3	x4	x5	x6	x7	x8
	H Profil Profile Profil Profiel	x1	x2	x3	x4	x5	x6	x7
	i Vis Screw Schraube schroef	x4	x6	x8	x10	x12	x14	x16
	J Écrou Nut Mutter Moer	x2	x2	x2	x2	x2	x2	x2
	K Mousse adhésive Adhesive foam Klebschaum Zelfklevend schuim	x6	x6	x6	x6	x6	x6	x6
	L Petite cale Small wooden block Kleiner Holzblock Kleine houten blok	x2	x4	x6	x8	x10	x12	x14
	M Grande cale Large wooden block Großer Holzblock Grote houten blok	x2	x4	x6	x8	x10	x12	x14
	N Joint adhésif Adhesive gasket Klebedichtung Zelfklevende afdichting	x1	x1	x1	x1	x1	x1	x1
	O Insert Insert Verbindungsstück Invoegen	x4	x6	x8	x10	x12	x14	x16



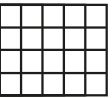
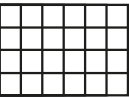
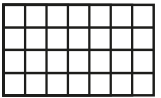
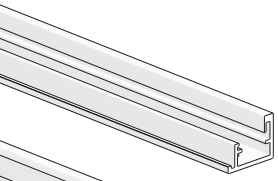

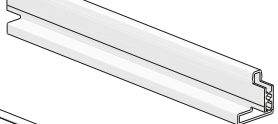
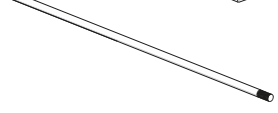
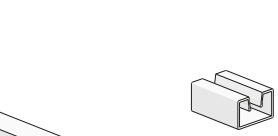
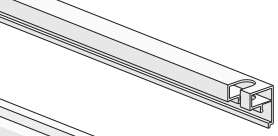
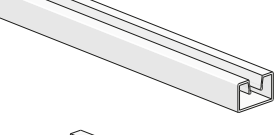
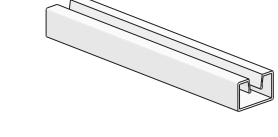
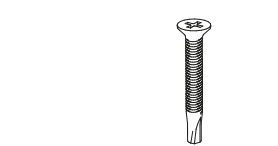
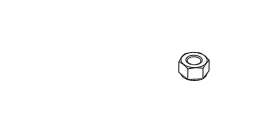
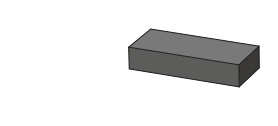
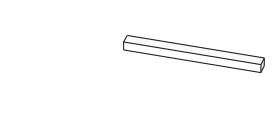
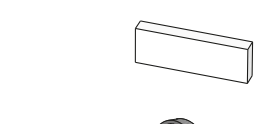

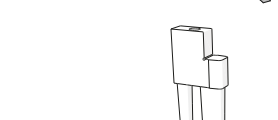

COMPOSITION DE VOTRE COLIS / INCLUDED IN THE PACKAGE / PACKETINHALT / INHOUD VAN DE VERPAKKING

Hauteur 3 carreaux		x1	x2	x3	x4	x5	x6	x7
								
	A Profil Profile Profil Profiel	x2	x2	x2	x2	x2	x2	x2
	B Profil Profile Profil Profiel	x2	x3	x4	x5	x6	x7	x8
	C Profil Profile Profil Profiel	x2	x4	x6	x8	x10	x12	x14
	D Tige Spindle Stange Draadstang	x2	x2	x2	x2	x2	x2	x2
	E Profil Profile Profil Profiel	x2	x4	x6	x8	x10	x12	x14
	F Profil Profile Profil Profiel	x2	x2	x2	x2	x2	x2	x2
	G Profil Profile Profil Profiel	x2	x3	x4	x5	x6	x7	x8
	H Profil Profile Profil Profiel	x2	x4	x6	x8	x10	x12	x14
	i Vis Screw Schraube schroef	x4	x6	x8	x10	x12	x14	x16
	J Écrou Nut Mutter Moer	x4	x4	x4	x4	x4	x4	x4
	K Mousse adhésive Adhesive foam Klebschaum Zelfklevend schuim	x6	x6	x6	x6	x6	x6	x6
	L Petite cale Small wooden block Kleiner Holzblock Kleine houten blok	x4	x8	x12	x16	x20	x24	x28
	M Grande cale Large wooden block Großer Holzblock Grote houten blok	x2	x4	x6	x8	x10	x12	x14
	N Joint adhésif Adhesive gasket Klebedichtung Zelfklevende afdichting	x1	x1	x1	x1	x1	x1	x1
	O Insert Insert Verbindungsstück Invoegen	x4	x6	x8	x10	x12	x14	x16

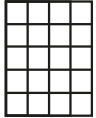
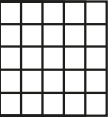
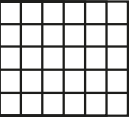
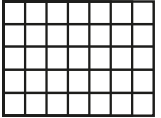
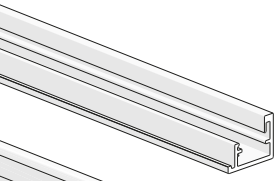
COMPOSITION DE VOTRE COLIS / INCLUDED IN THE PACKAGE / PACKETINHALT / INHOUD VAN DE VERPAKKING

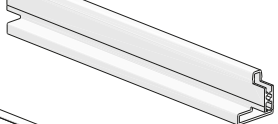
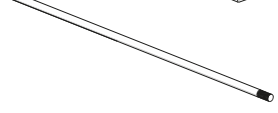
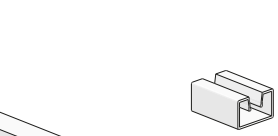
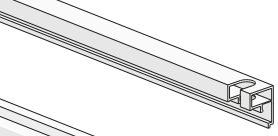
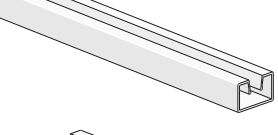
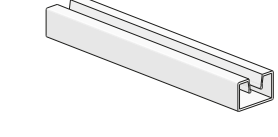
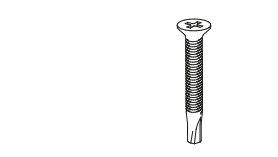
Hauteur 4 carreaux		x1	x2	x3	x4	x5	x6	x7	
									
	A	Profil Profile Profil Profiel	x2	x2	x2	x2	x2	x2	x2
	B	Profil Profile Profil Profiel	x2	x3	x4	x5	x6	x7	x8
	C	Profil Profile Profil Profiel	x3	x6	x9	x12	x15	x18	x21
	D	Tige Spindle Stange Draadstang	x3	x3	x3	x3	x3	x3	x3
	E	Profil Profile Profil Profiel	x3	x6	x9	x12	x15	x18	x21
	F	Profil Profile Profil Profiel	x2	x2	x2	x2	x2	x2	x2
	G	Profil Profile Profil Profiel	x2	x3	x4	x5	x6	x7	x8
	H	Profil Profile Profil Profiel	x3	x6	x9	x12	x15	x18	x21
	i	Vis Screw Schraube schroef	x4	x6	x8	x10	x12	x14	x16
	J	Écrou Nut Mutter Moer	x6	x6	x6	x6	x6	x6	x6
	K	Mousse adhésive Adhesive foam Klebschaum Zelfklevend schuim	x6	x6	x6	x6	x6	x6	x6
	L	Petite cale Small wooden block Kleiner Holzblock Kleine houten blok	x6	x12	x18	x24	x30	x36	x42
	M	Grande cale Large wooden block Großer Holzblock Grote houten blok	x2	x4	x6	x8	x10	x12	x14
	N	Joint adhésif Adhesive gasket Klebedichtung Zelfklevende afdichting	x1	x1	x1	x1	x1	x1	x1
	O	Insert Insert Verbindungsstück Invoegen	x4	x6	x8	x10	x12	x14	x16

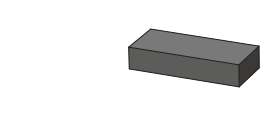
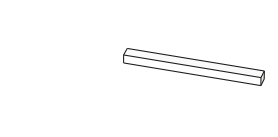
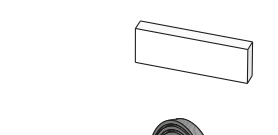
COMPOSITION DE VOTRE COLIS / INCLUDED IN THE PACKAGE / PACKETINHALT / INHOUD VAN DE VERPAKKING

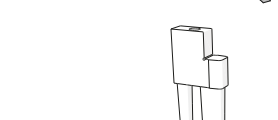
		x1	x2	x3	x4	x5	x6	x7
Hauteur 5 carreaux								
	A Profil Profile Profil Profiel	x2	x2	x2	x2	x2	x2	x2
	B Profil Profile Profil Profiel	x2	x3	x4	x5	x6	x7	x8
	C Profil Profile Profil Profiel	x4	x8	x12	x16	x20	x24	x28
	D Tige Spindle Stange Draadstang	x4	x4	x4	x4	x4	x4	x4
	E Profil Profile Profil Profiel	x4	x8	x12	x16	x20	x24	x28
	F Profil Profile Profil Profiel	x2	x2	x2	x2	x2	x2	x2
	G Profil Profile Profil Profiel	x2	x3	x4	x5	x6	x7	x8
	H Profil Profile Profil Profiel	x4	x8	x12	x16	x20	x24	x28
	i Vis Screw Schraube schroef	x4	x6	x8	x10	x12	x14	x16
	J Écrou Nut Mutter Moer	x8	x8	x8	x8	x8	x8	x8
	K Mousse adhésive Adhesive foam Klebeschäum Zelfklevend schuim	x8	x8	x8	x8	x8	x8	x8
	L Petite cale Small wooden block Kleiner Holzblock Kleine houten blok	x8	x16	x24	x32	x40	x48	x56
	M Grande cale Large wooden block Großer Holzblock Grote houten blok	x2	x4	x6	x8	x10	x12	x14
	N Joint adhésif Adhesive gasket Klebedichtung Zelfklevende afdichting	x1	x1	x1	x1	x1	x1	x1
	O Insert Insert Verbindungsstück Invoegen	x4	x6	x8	x10	x12	x14	x16

ÉTAPE 1 - STEP 1 - SCHRITT 1 - STAP 1

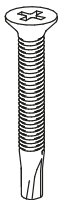
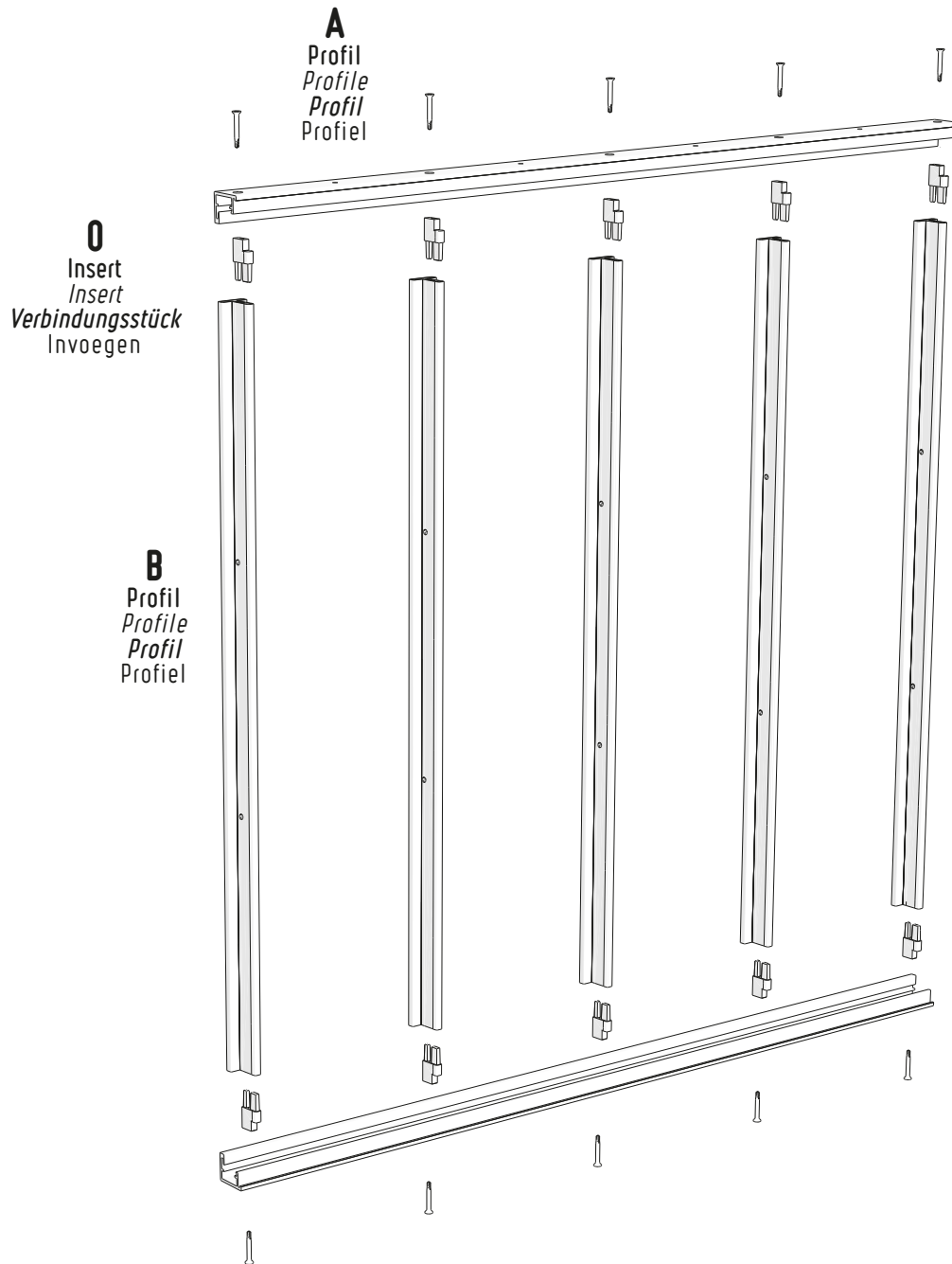

i
Vis
Schraube
schroef

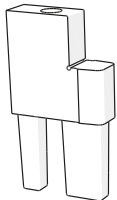

0
Insert
Insert
Verbindungsstück
Invoegen

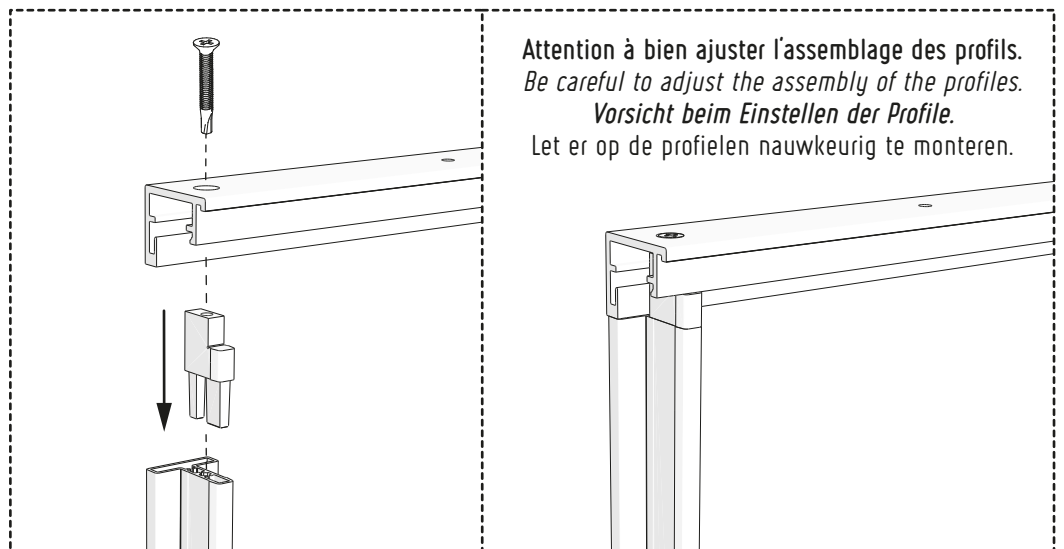

Attention à bien ajuster l'assemblage des profils.
Be careful to adjust the assembly of the profiles.
Vorsicht beim Einstellen der Profile.
Let er op de profielen nauwkeurig te monteren.

ÉTAPE 2 - STEP 2 - SCHRITT 2 - STAP 2

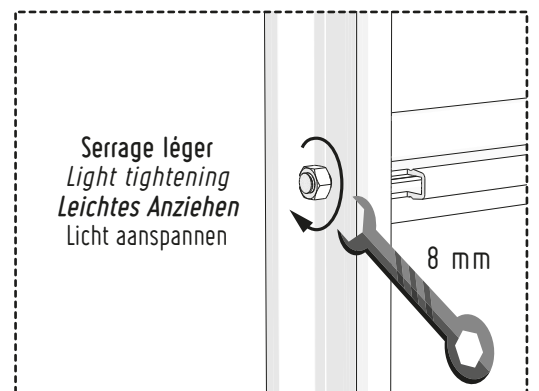
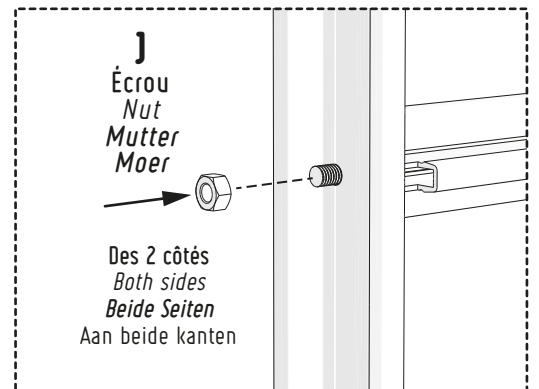
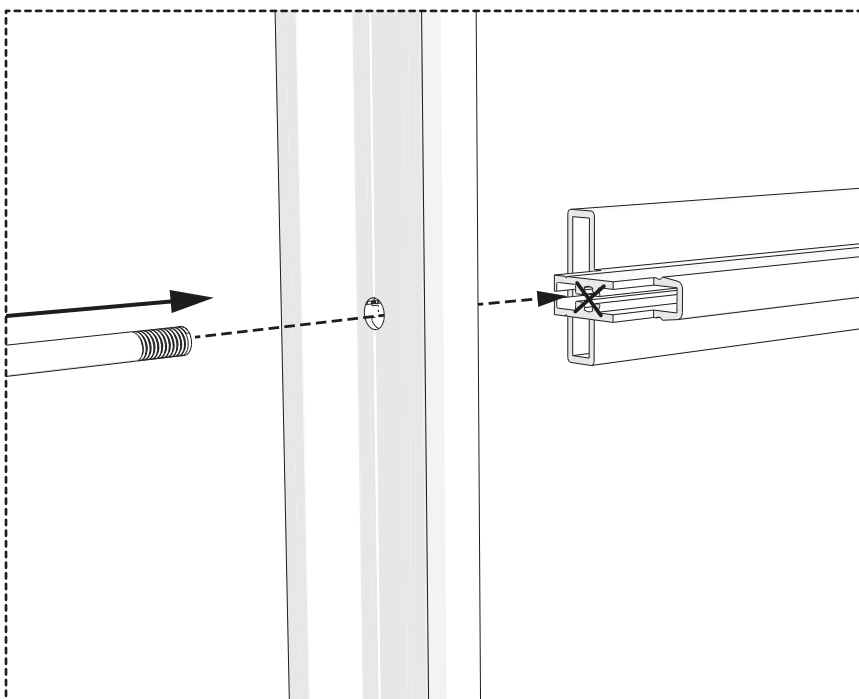
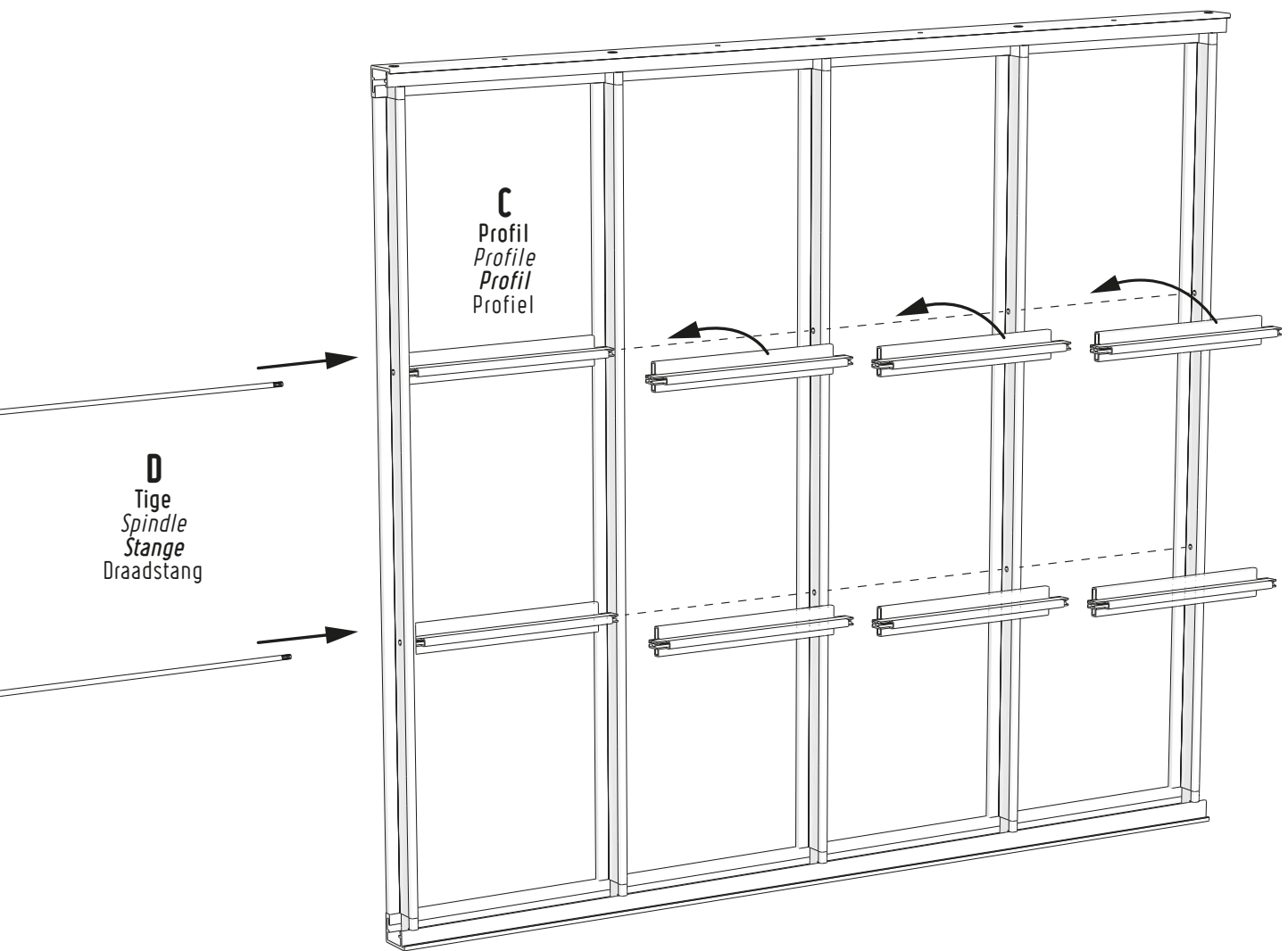

ÉTAPE 3 - STEP 3 - SCHRITT 3 - STAP 3

FR

Pour l'installation d'un poteau d'angle ou d'un poteau de terminaison, suivez la notice présente sur leur emballage. (Installation à effectuer avant la pose des mousses adhésives).

EN

To install the corner profile or the angle profile, please follow the instructions mentioned on the packaging. (installation to be done before the application of the adhesive foams).

DE

Zur Montage des Eckprofils oder des Abschlussprofils die Anweisungen auf der entsprechenden Verpackung beachten. (Vor dem Anbringen des Klebeschaums, müssen die Profile vorab montiert werden).

NL

Voor de installatie van een hoekprofiel of een eindprofiel, volg de instructies op de verpakking. (installeren vóór de plaatsing van de schuimblokjes)

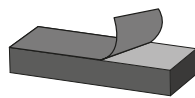
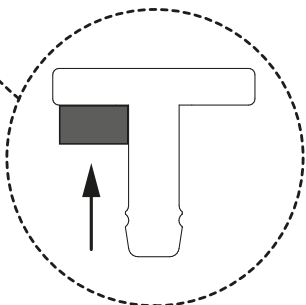
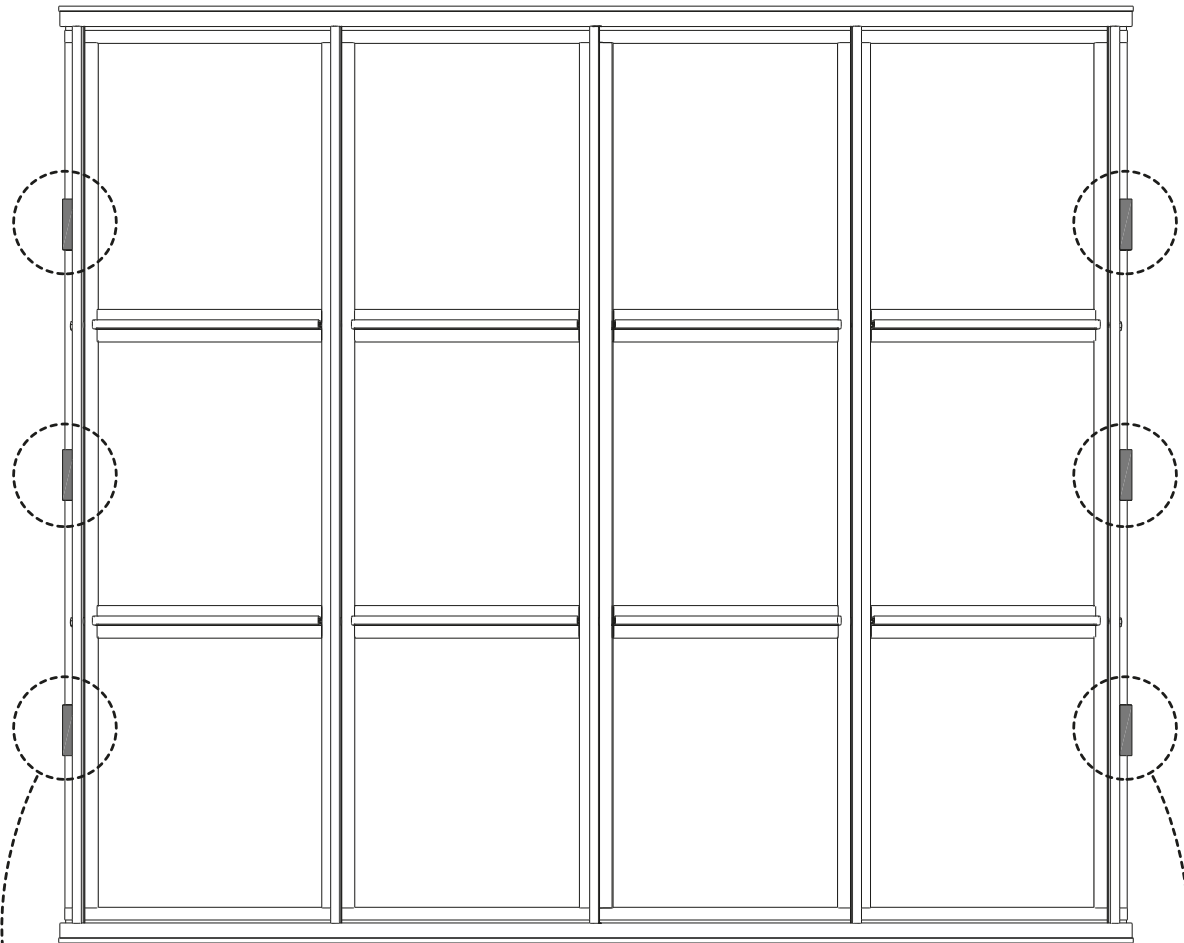
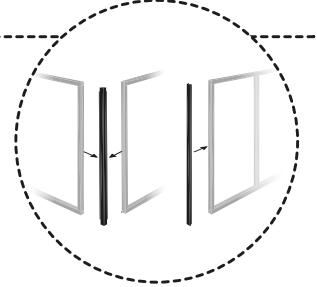

K
Mousse adhésive
Adhesive foam
Klebeschäum
Zelfklevend schuim

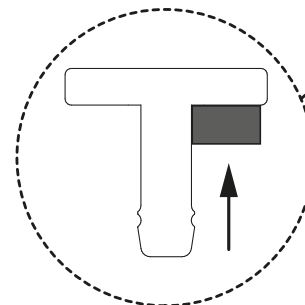

ÉTAPE 4 - STEP 4 - SCHRITT 4 - STAP 4

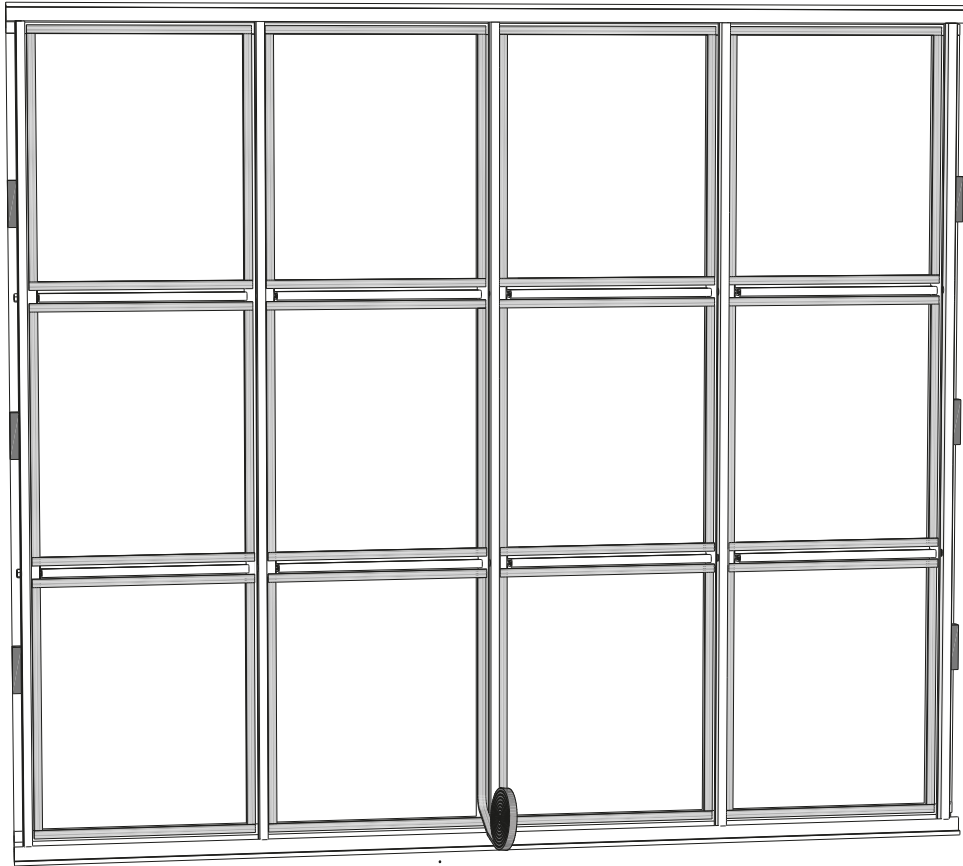

N
Joint adhésif
Adhesive gasket
Klebedichtung
Zelfklevende afdichting

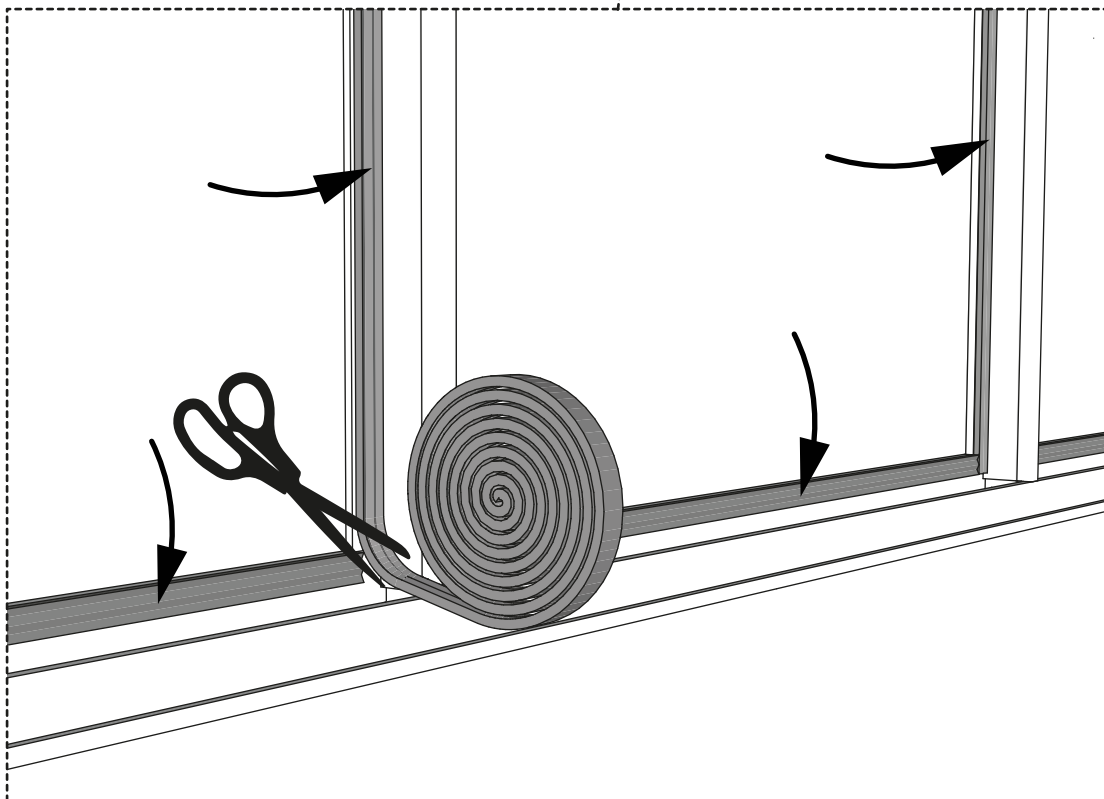

!
Alignement
Alignment
Ausrichtung
Uitlijning

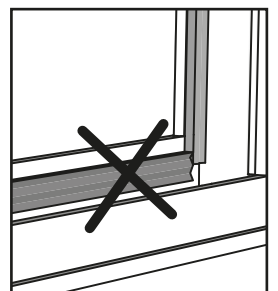
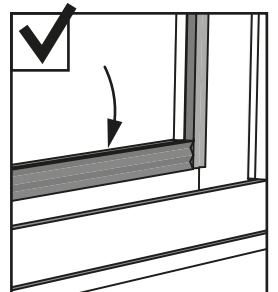

ÉTAPE 5 - STEP 5 - SCHRITT 5 - STAP 5

MUR
WALL
MAUER
MUUR

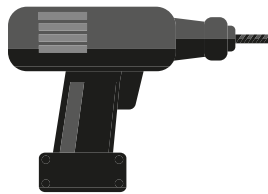
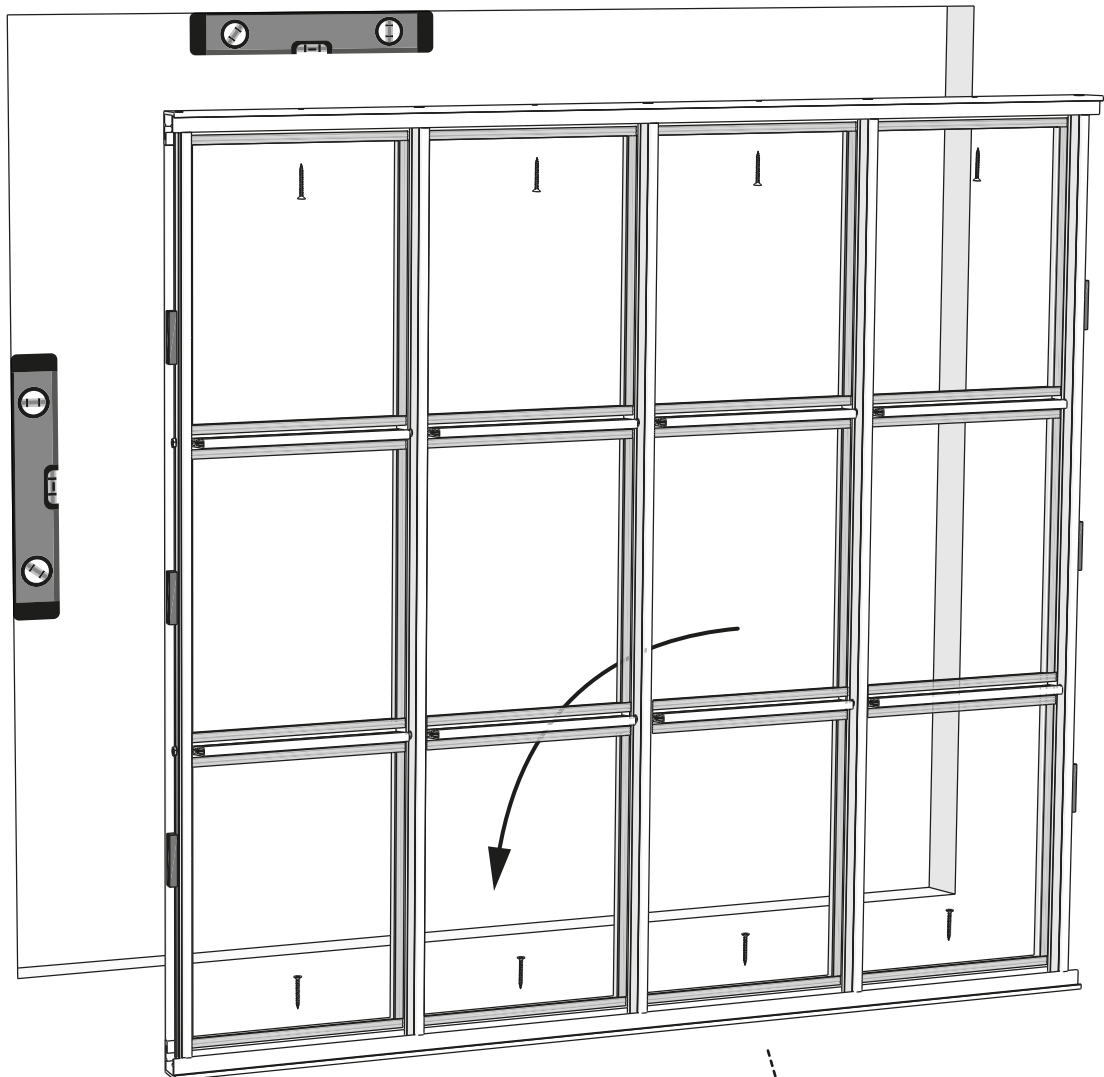

Vis (non fournies)
à adapter selon votre support.

*Screw (not provided)
to adapt accordingly to your support.*

*Schrauben nicht im Lieferumfang enthalten.
Befestigung entsprechend dem Träger
(Holz, Beton, usw.) verwenden.*

*Schroeven (niet meegeleverd)
aan te passen volgens de wand.*

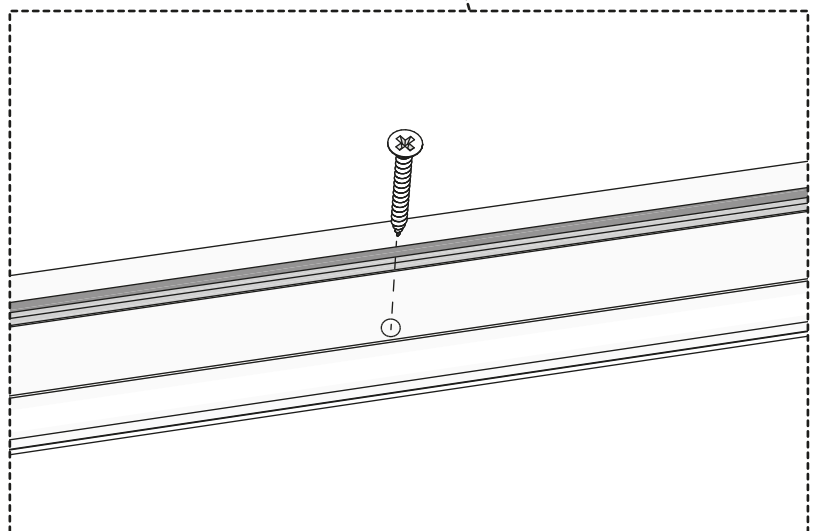

ÉTAPE 6 - STEP 6 - SCHRITT 6 - STAP 6

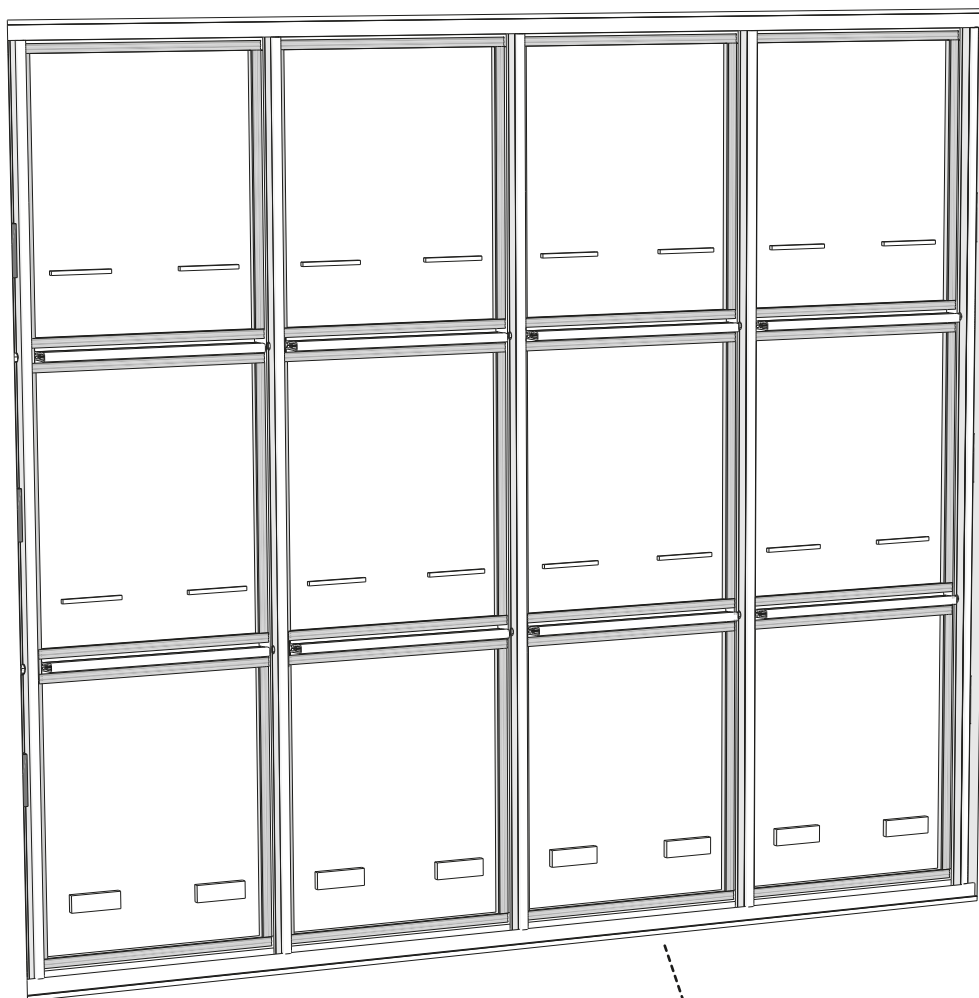

L

Petite cale
Small wooden block
Kleiner Holzblock
Kleine houten blok



M

Grande cale
Large wooden block
Großer Holzblock
Grote houten blok

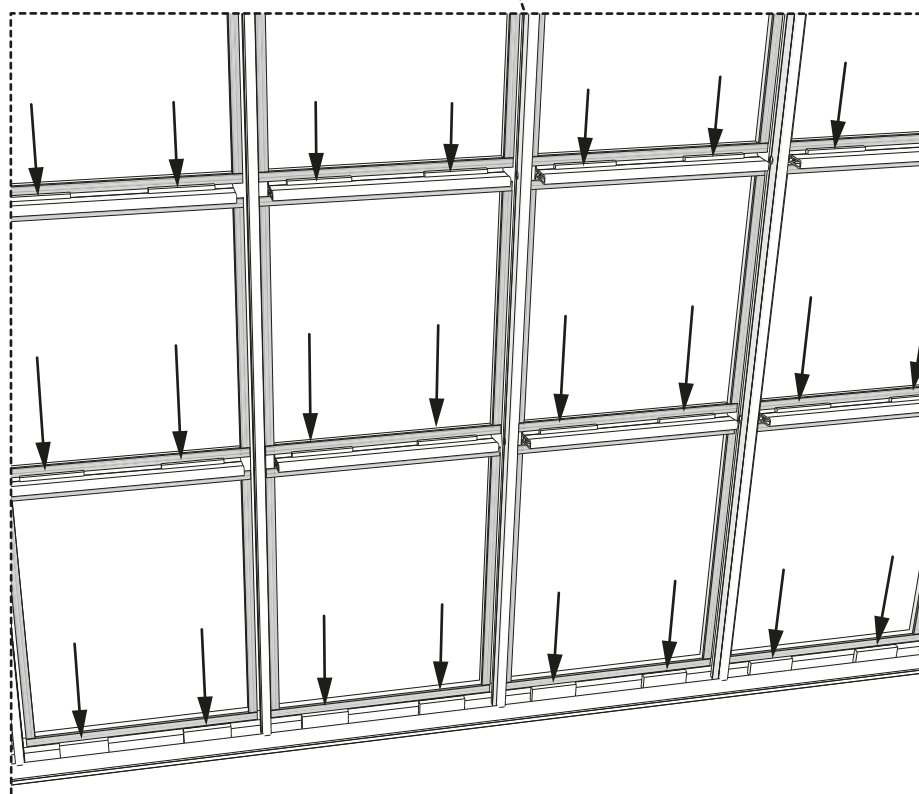

ÉTAPE 7 - STEP 7 - SCHRITT 7 - STAP 7

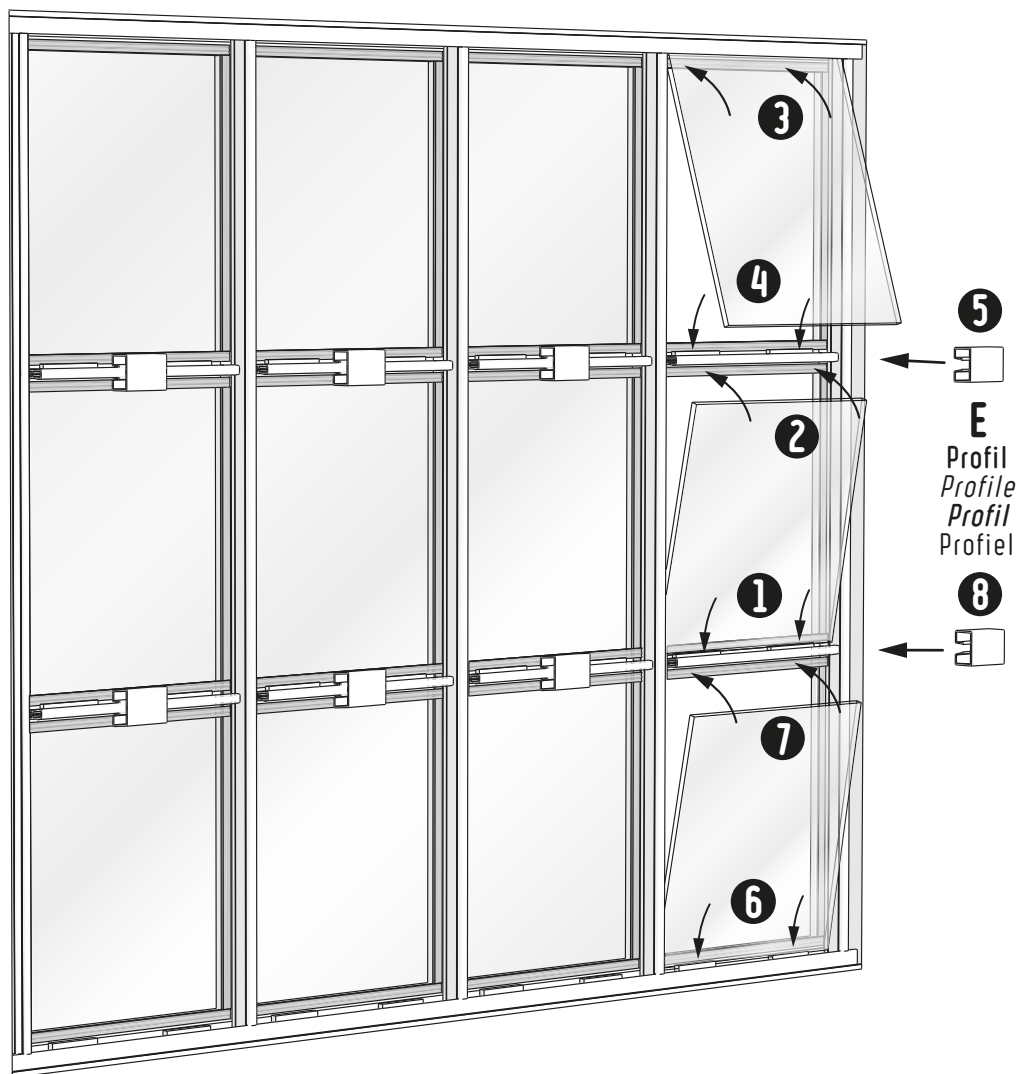

Répétez ces 8 étapes pour chaque travée.
Les vitrages doivent être maintenus jusqu'à l'étape ⑧.

*Repeat these 8 steps for each bay.
The glazing must be maintained until step ⑧.*

*Wiederholen Sie diese 8 Schritte für jeden Schacht.
Die Verglasung muss bis Schritt ⑧. erhalten bleiben.*

Herhaal deze 8 stappen voor elke dwarsbalk.
Het glas moet op zijn plaats worden gehouden tot stap ⑧.

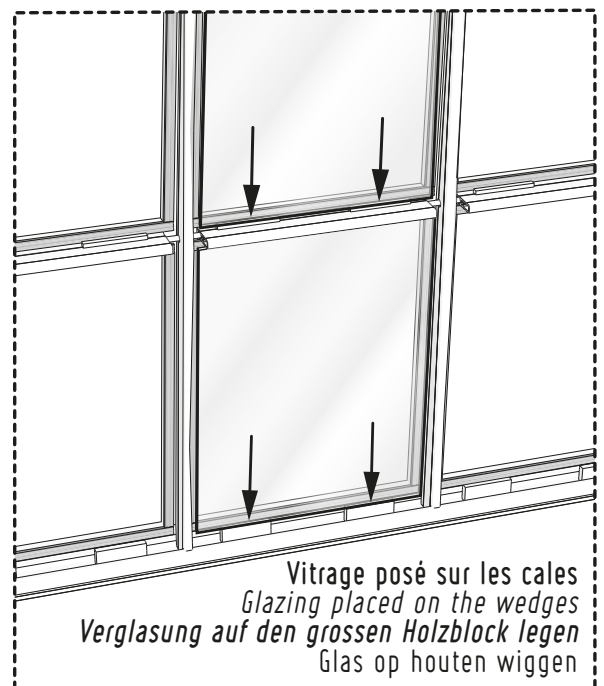

ÉTAPE 8 - STEP 8 - SCHRITT 8 - STAP 8

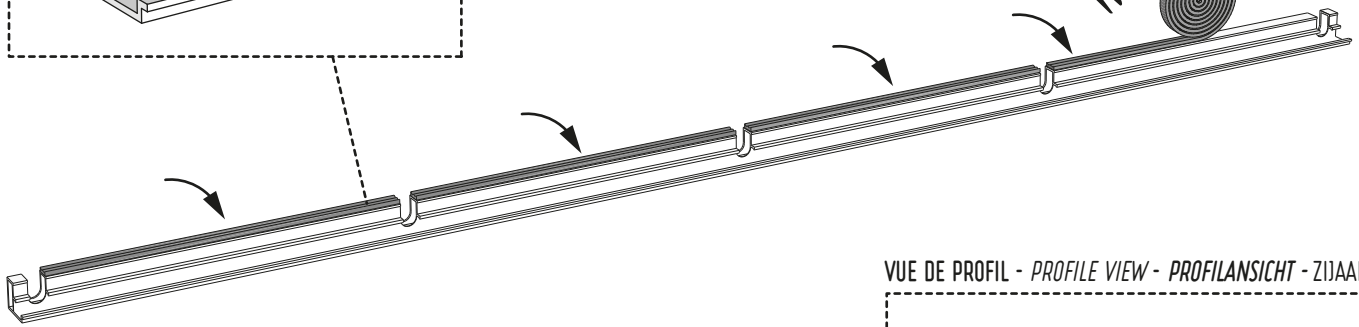
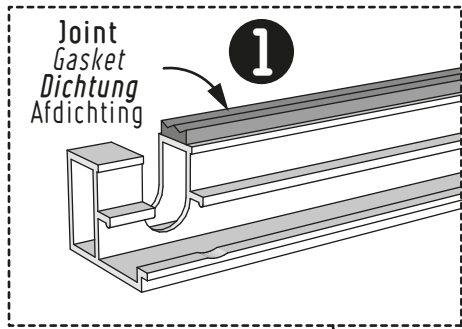

VUE DE PROFIL - PROFILE VIEW - PROFILANSICHT - ZIJAAZICHT

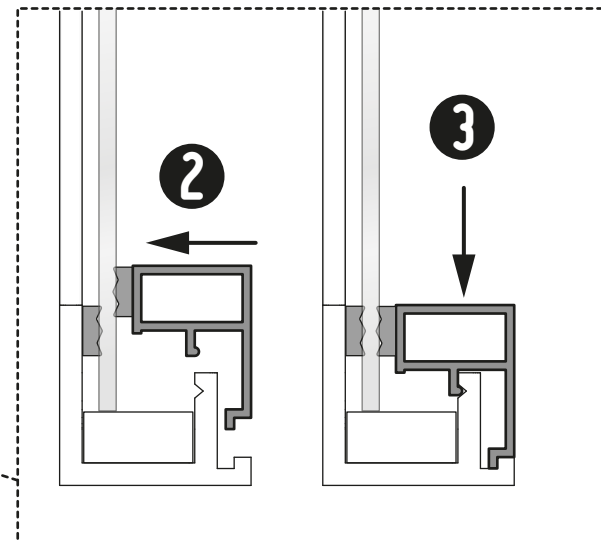
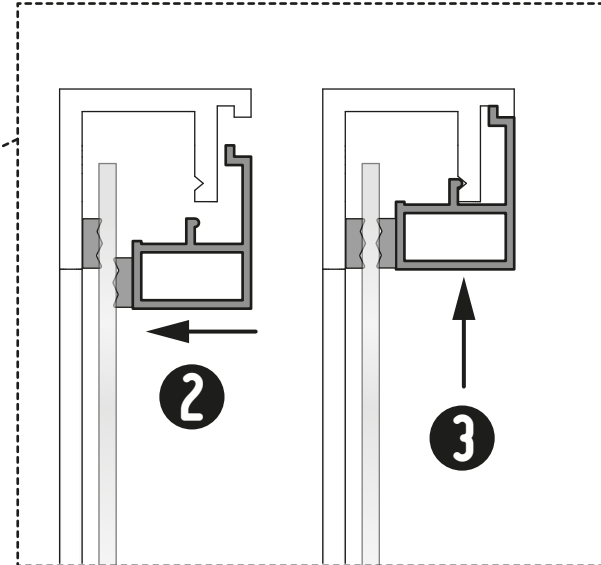
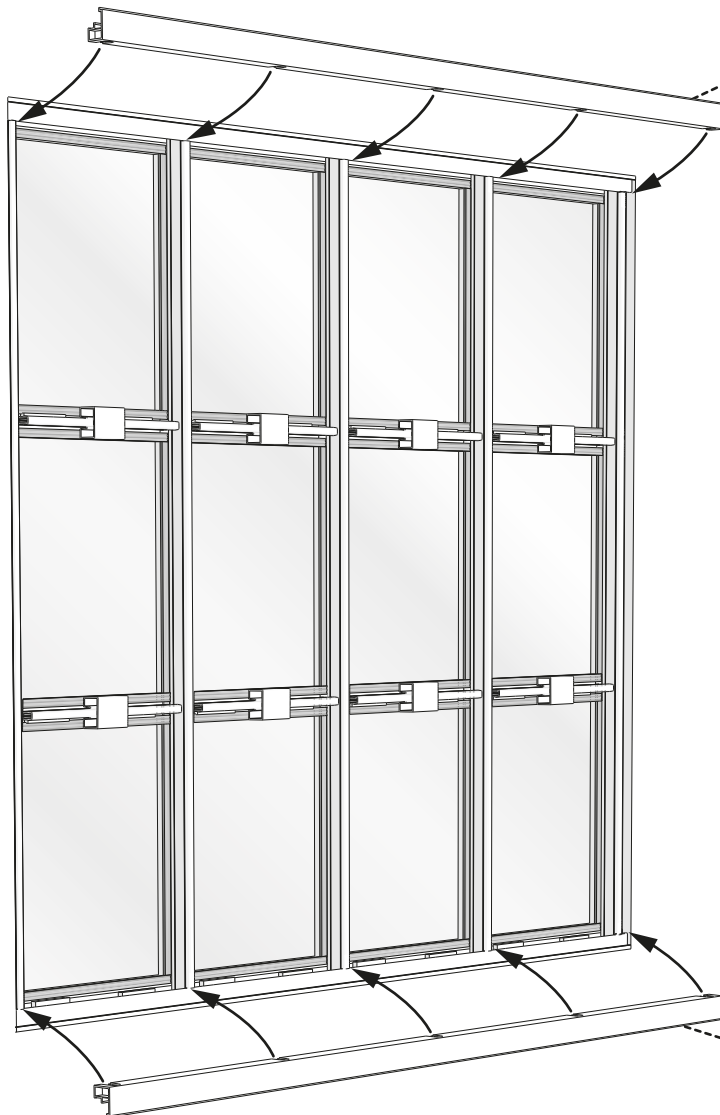

ÉTAPE 9 - STEP 9 - SCHRITT 9 - STAP 9

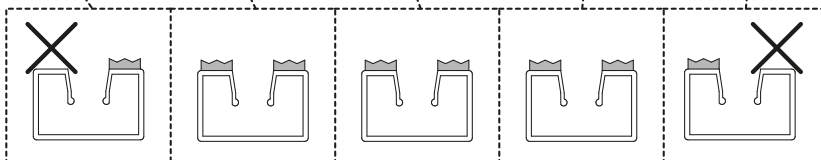
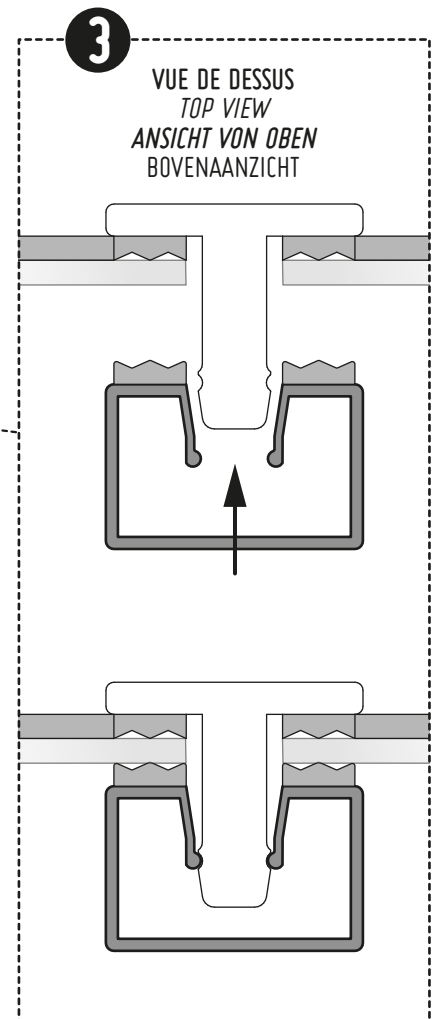
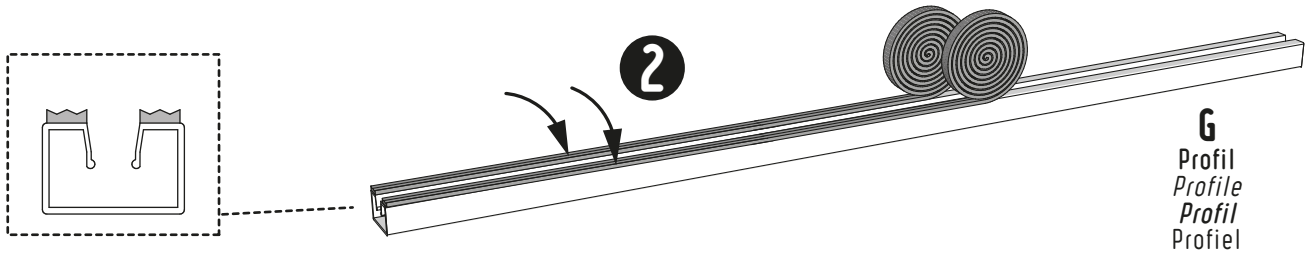
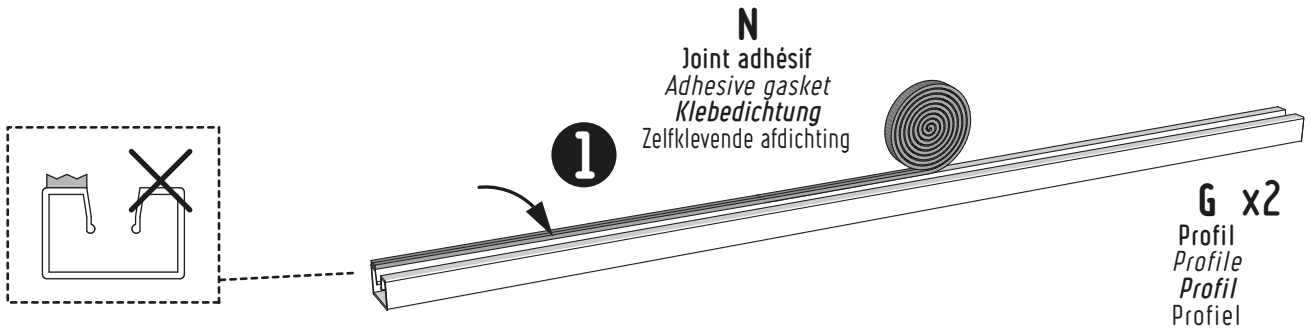

ÉTAPE 10 - STEP 10 - SCHRITT 10 - STAP 10



N
Joint adhésif
Adhesive gasket
Klebedichtung
Zelfklevende afdichting

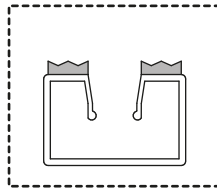

2

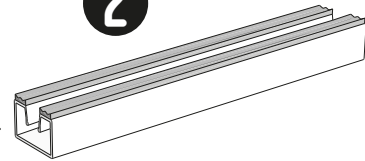

H
Profil
Profile
Profil
Profiel

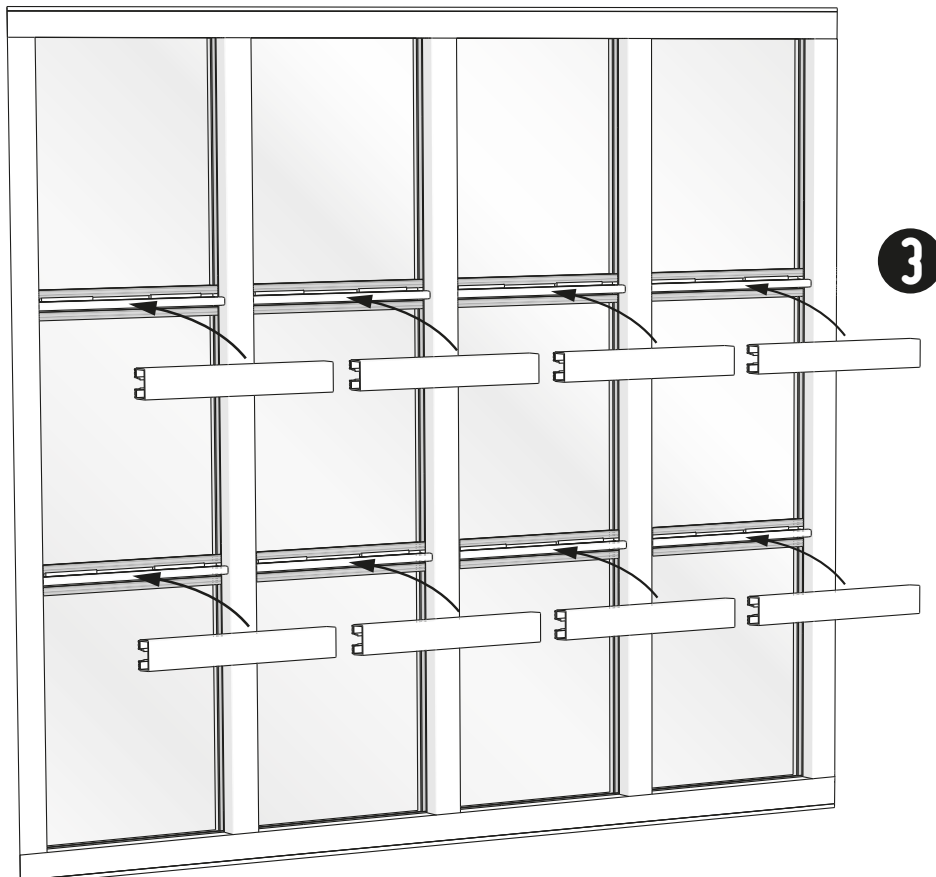

Félicitations ! *Congratulations ! Herzliche Glückwünsche!* Gefeliciteerd!