



ALU-D'ORS

OMKEERBARE DEUR

INSTALLATIEHANDLEIDING



NODIGE MATERIAAL (Niet meegeleverd)

schroefboormachine

Rubberhamer



Bevestigingsschroeven,
aangepast aan de drager (x8)

Kruiskopschroevendraaier



Inbussleutel 4



OMKEERBARE DEUR

SAMENSTELLING VAN DE VERPAKING

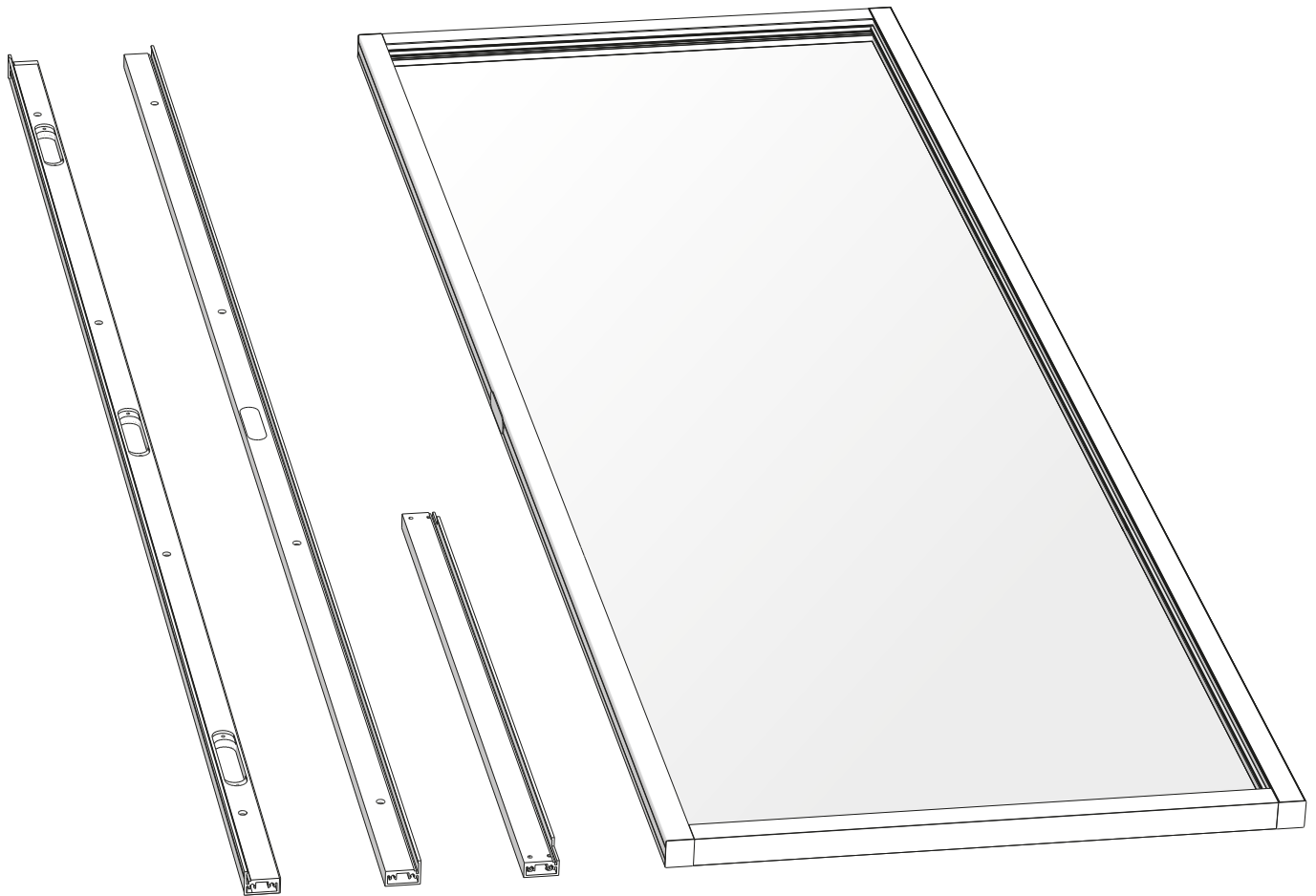

A Scharnierkant **B** Slotkant **C** Kopstuk **D** Beglasde deur

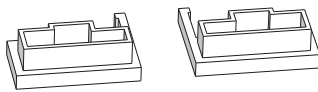

E Voet 1 **F** Voet 2

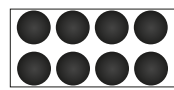

G Schroef-afdekkapje (x8)



H Grote zelftappende schroef (x4)



i Kleine platte schroef (x6)



J Kleine zelftappende schroef (x4)

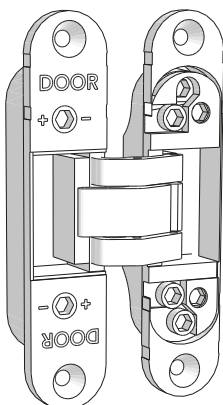

K Onzichtbare scharnieren (x3)

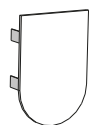

L Afdekkapje (x12)

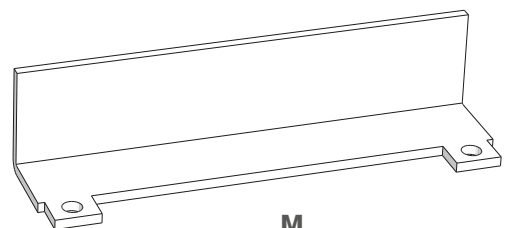

M Handgreep (x2)

STAP 1

ASSEMBLAGE VAN HET KADER A + B + C

Kruiskopschroevendraaier



INSTALLATIE VAN HET KADER VOOR EEN LINKS OPEN DUWENDE DEUR (EuR)

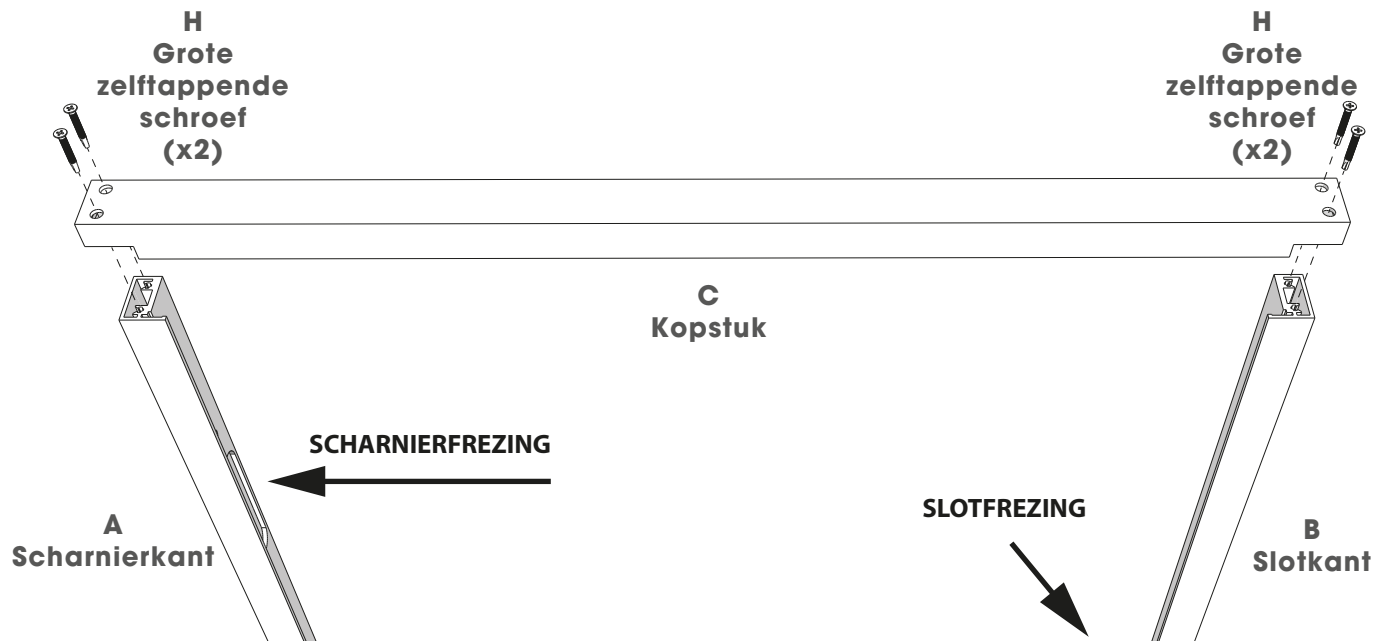
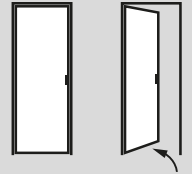

OF

INSTALLATIE VAN HET KADER VOOR EEN RECHTS OPEN DUWENDE DEUR (EuL)

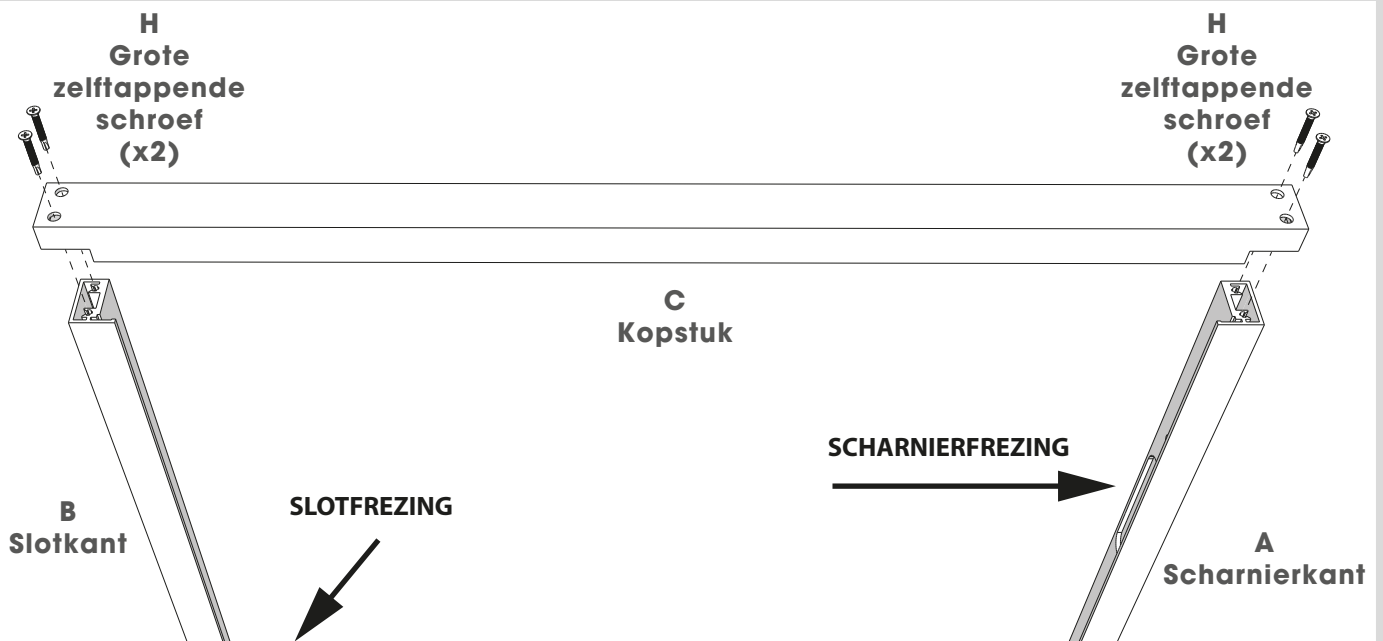
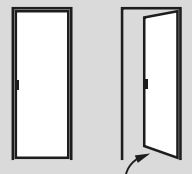

STAP 2

PLAATSING VAN DE VOETEN E EN F

Rubberhamer

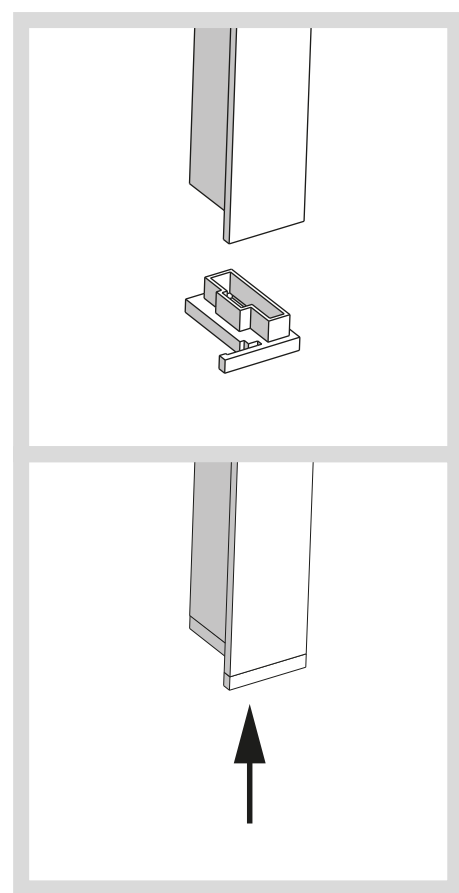
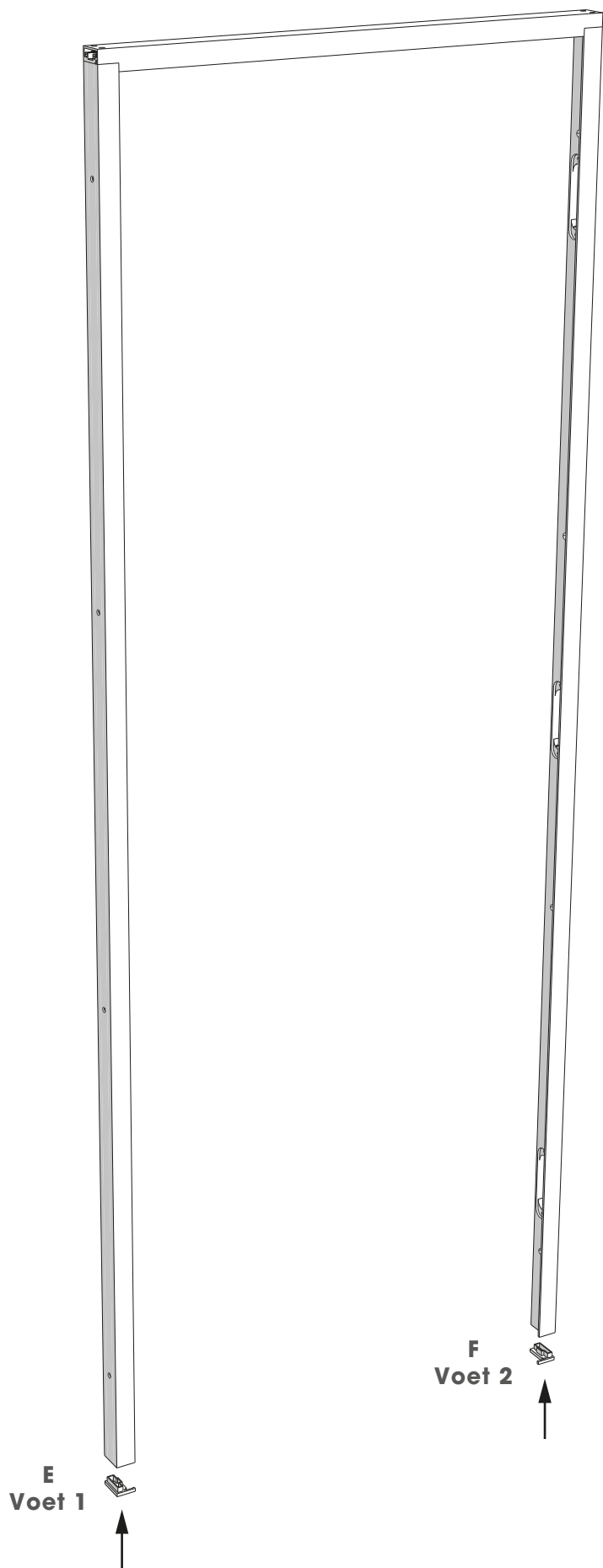
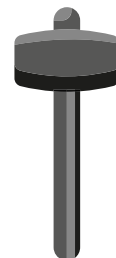

STAP 3

BEVESTIGING VAN HET KADER OP DE MUUR (MET AFDEKKAPJES)

MUUR

Schroefboormachine

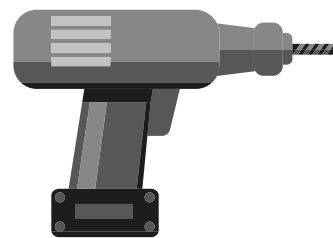

Bevestigingsschroeven,
aangepast aan de drager
(x8)

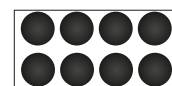
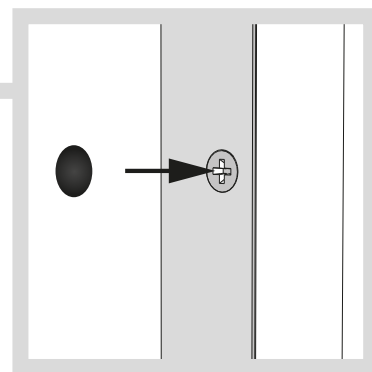

G
Afdekkapjes
(x8)

STAP 4

BEVESTIGING VAN DE SCHARNIEREN K OP HET KADER

Kruiskopschroevendraaier

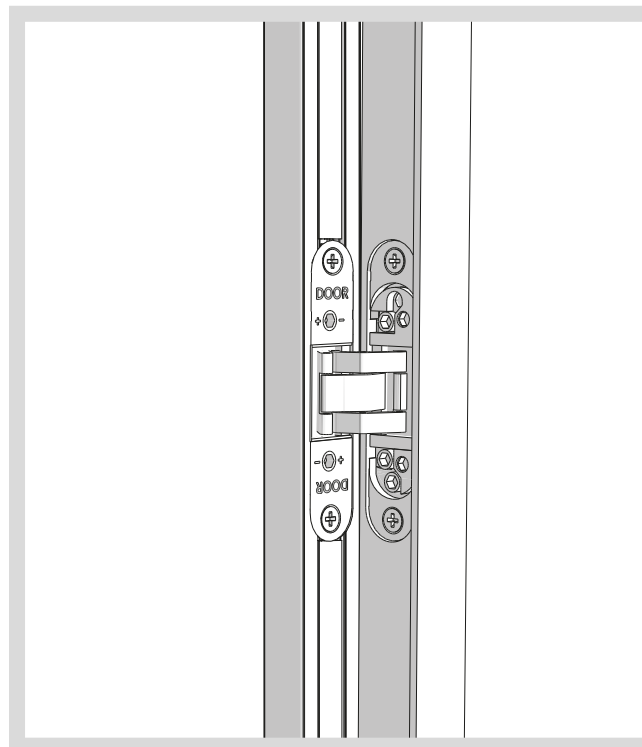
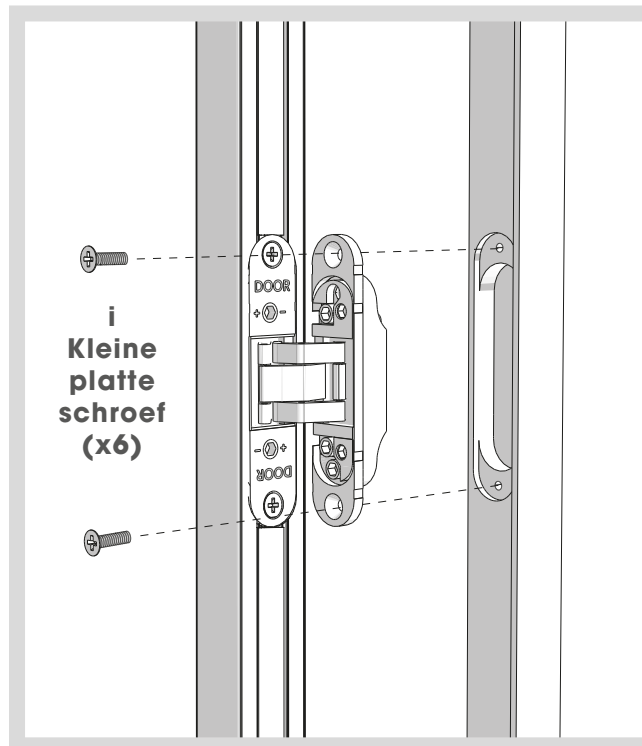
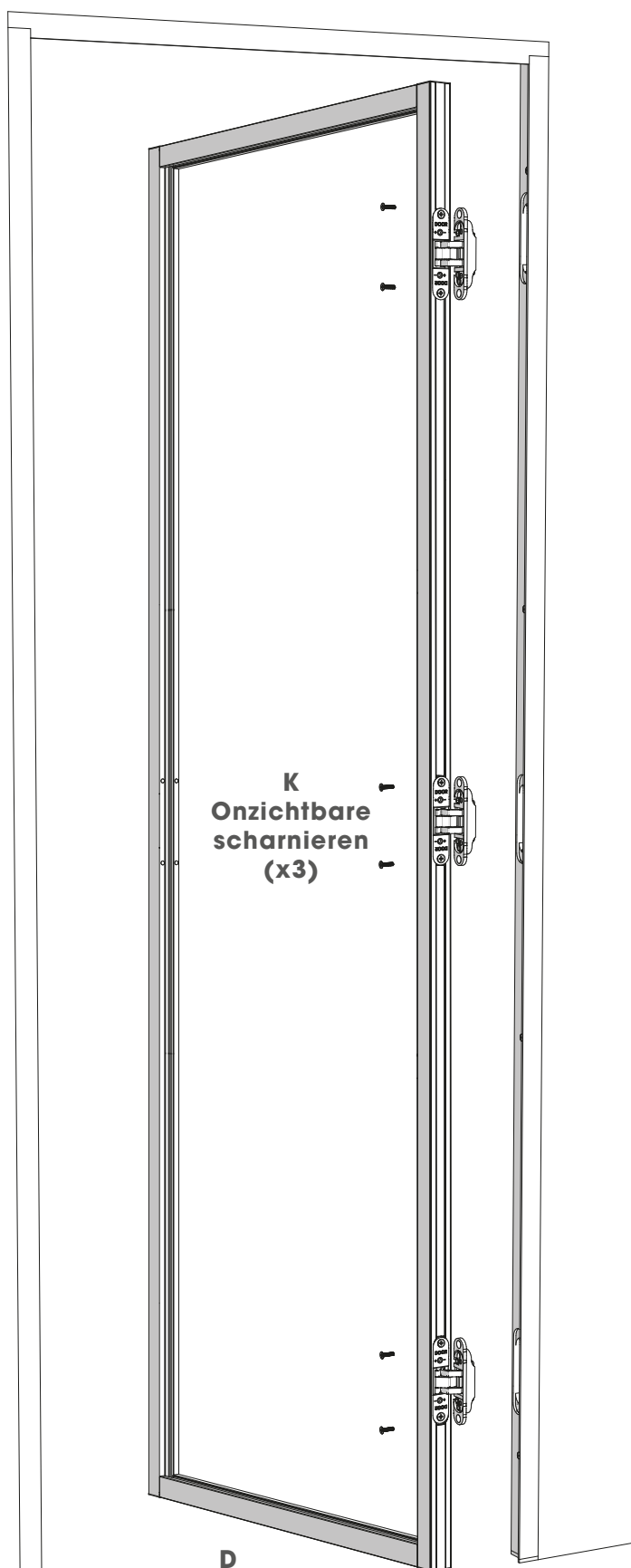

STAP 5

AFREGELING VAN DE SCHARNIEREN EN PLAATSEN VAN DE AFDEKKAPJES L

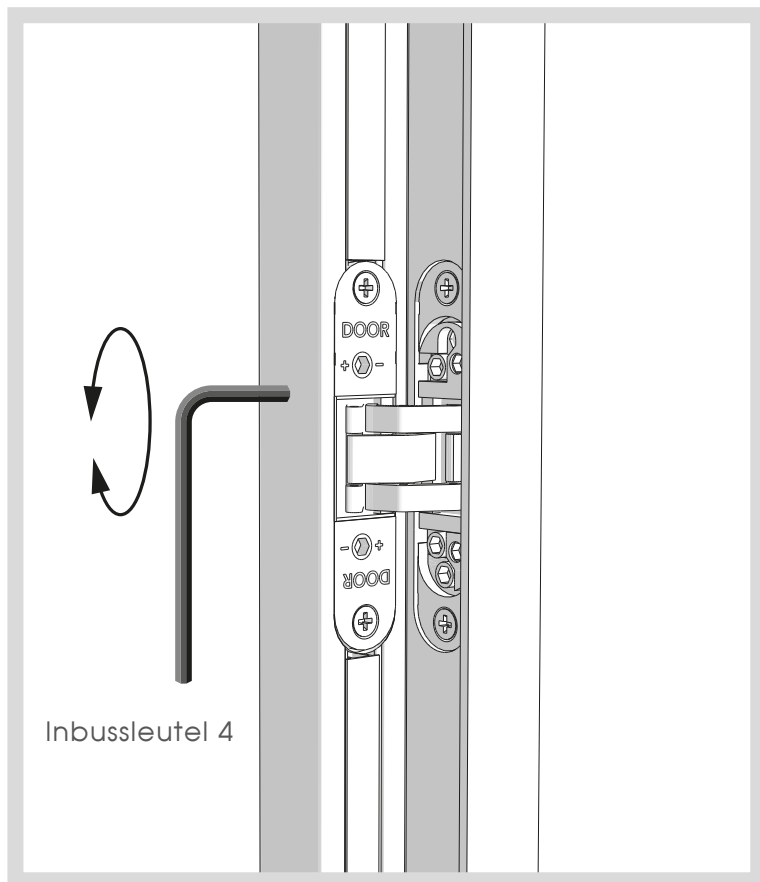

De scharnieren kunnen worden afgeregeld met behulp van een inbusleutel 4.

Progressief driedimensionaal afgeregelen :
+/- 2mm in de hoogte en de breedte
+/- 1mm in de diepte

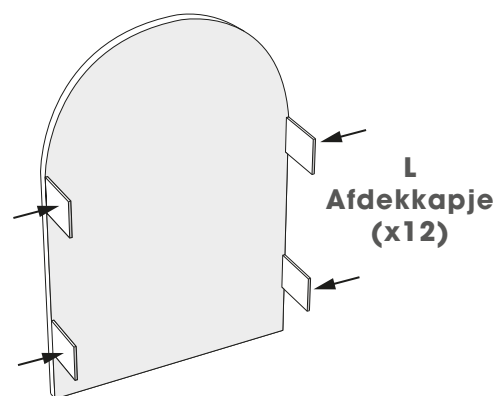
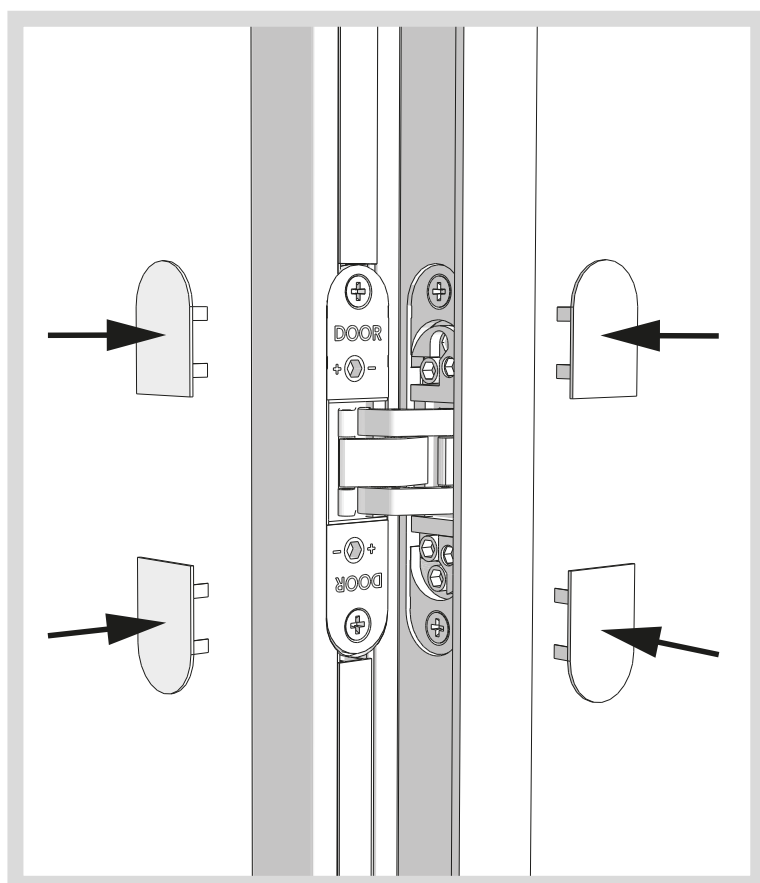

Plooi de lipjes voorzichtig om naar binnen en oefen terzelfdertijd een lichte druk uit. Klik vervolgens de afdekkapjes op de scharnieren.

